

PHI ARROW

GREENLED

[FI] Asennusohje
[UK] Installation instruction
[SE] Installationsanvisning

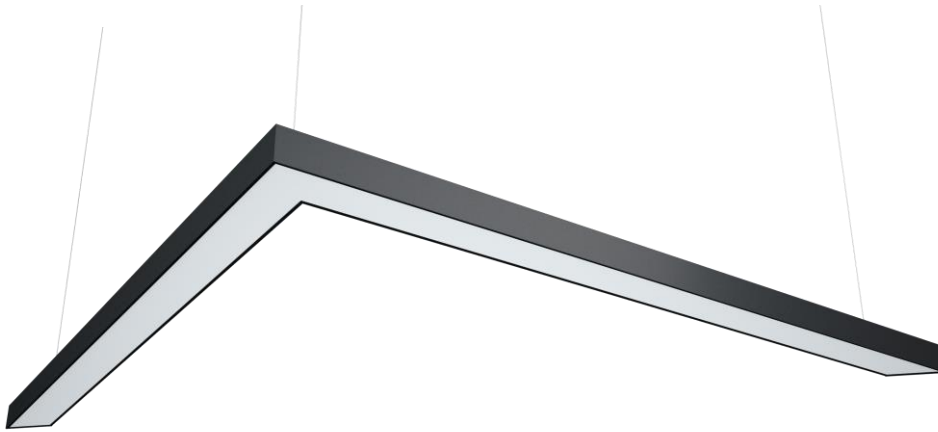

IP20

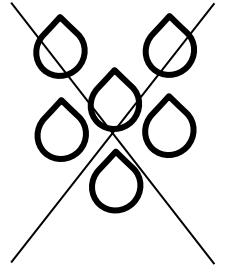

Mallin mitta Model measure	Teho Power	Paino Weight
GLPA0103012, PHI ARROW 1245	30W	8,8kg
GLPA0104412, PHI ARROW 1245	44W	8,8kg
GLPA0106212, PHI ARROW 1245	62W	8,8kg
GLPA0104418, PHI ARROW 1805	44W	12,1kg
GLPA0106618, PHI ARROW 1805	66W	12,1kg
GLPA0109018, PHI ARROW 1805	90W	12,1kg
GLPA0105823, PHI ARROW 2365	58W	15,2kg
GLPA0108623, PHI ARROW 2365	86W	15,2kg
GLPA0111623, PHI ARROW 2365	116W	15,2kg
GLPA0106029, PHI ARROW 2925	60W	18,1kg
GLPA0114429, PHI ARROW 2925	144W	18,1kg

Greenled Oy
Oritkarintie 4
FI-90400 Oulu



DOC00345,2-ASENNUSOHJE,Phi Arrow

GREENLED

PHI ARROW

[FI] Asennusohje
[UK] Installation instruction
[SE] Installationsanvisning

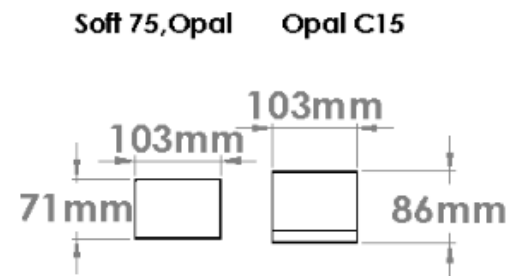
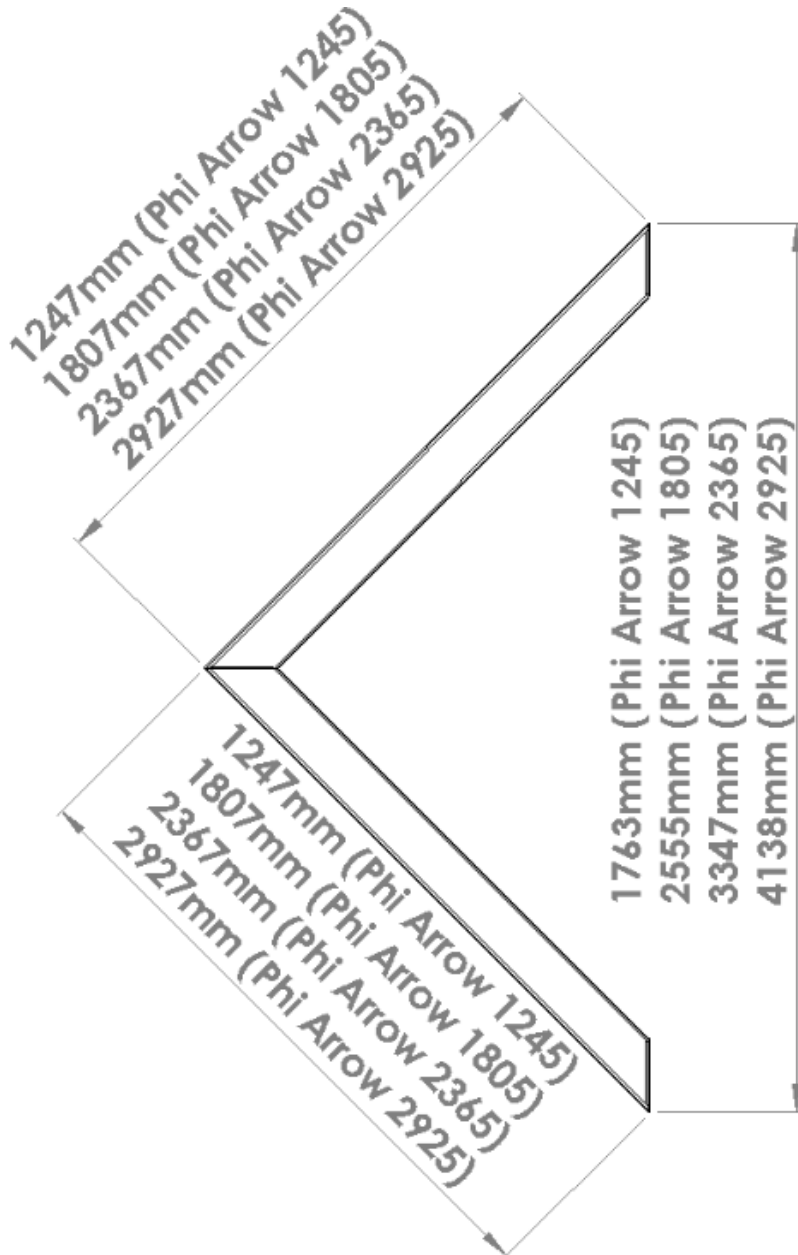



Turvallisuusvaroitukset:

Ennen asennusta tai huoltotyötä kytke valaisin irti sähköverkosta välttääksesi sähköiskun vaaran!

- Asennus / huoltotyön saa tehdä vain valtuutettu henkilö
- Valaisimen asennuksen / huoltotyön saa suorittaa vain pätevä henkilö näiden ohjeiden mukaisesti.
- Valmistaja ei kanna vastuuta valaisimen väärästä käytöstä
- Älä katso suoraan päällä olevaan valaisimeen
- Valaisimen valonlähteen saa vaihtaa ainoastaan Greenled, Greenledin valtuuttama huoltaja tai vastaavan pätevyyden omaava henkilö

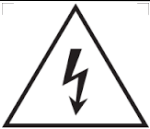

Safety notes:

Before installation or change work disconnect the power to reduce electrical shock risk!

- Installation / maintenance can only be done by a skilled personnel
- Installation / maintenance of luminaire must be performed by qualified person following the instructions given in the instruction set
- The manufacturer bears no liability for damage caused by inappropriate use or application
- Do not stare at the operating light source
- The light source contained in this luminaire shall only be replaced by the Greenled or Greenled's service agent or a similar qualified person



Säkerhetsvarningar:

Koppla alltid bort armaturen från elnätet i samband med installation ti den som använder armaturen.

- Installations- och underhållsarbeten får endast utföras av en behörig installatör
- Installations-/underhållsarbetet får endast utföras enligt dessa anvisningar av en person med tillräckliga kunskaper
- Tillverkaren ansvarar ej för felaktig användning av armaturen
- Titta aldrig rakt in i en påslagen armatur
- Ljuskällan inuti armaturen får endast bytas av antingen Greenled, en Greenled-auktoriserad servicetekniker eller en person med motsvarande kompetens

PHI ARROW

[FI] Asennusohje
[UK] Installation instruction
[SE] Installationsanvisning

1. Toimituksen sisältö. Delivery Content.

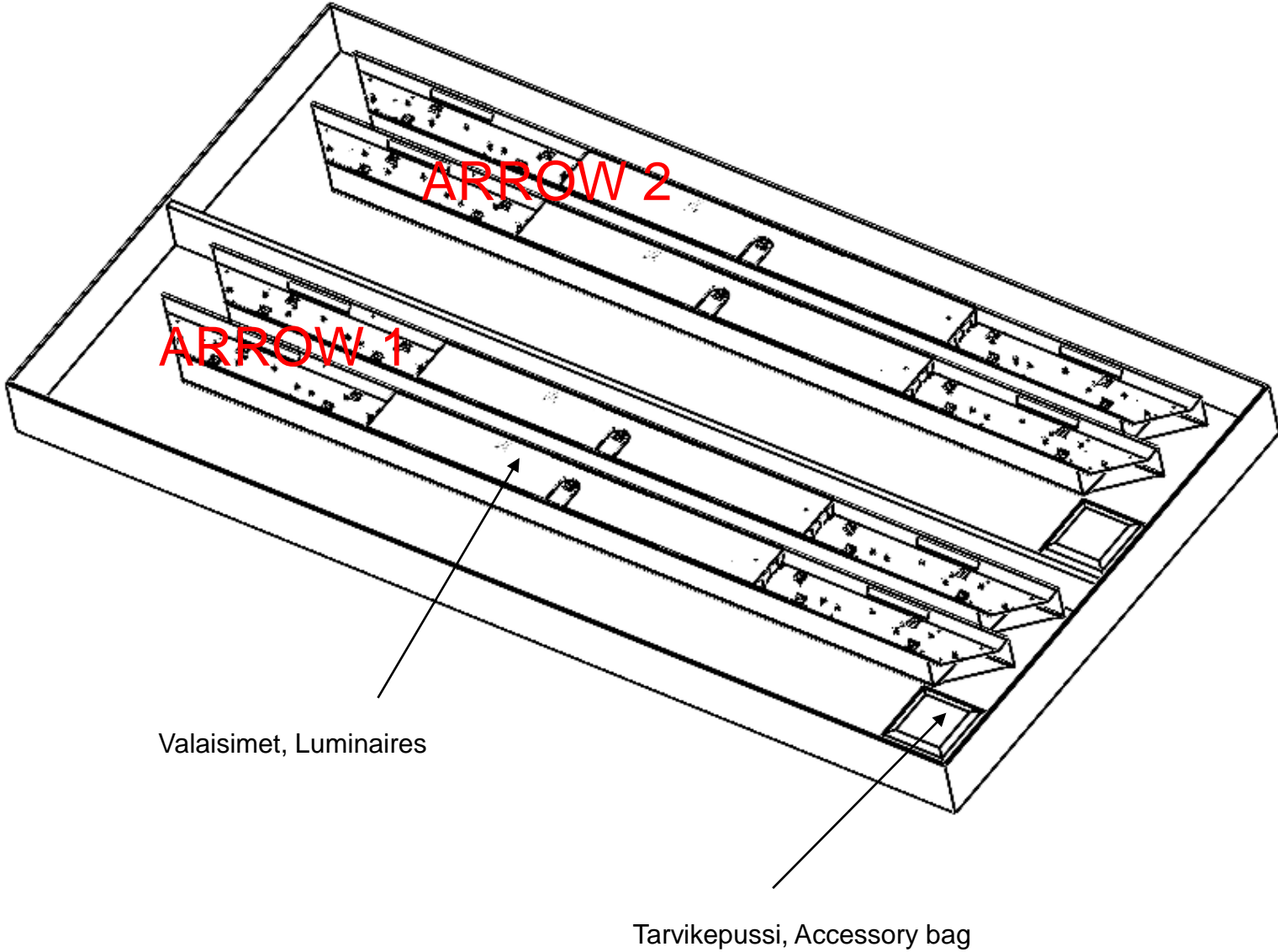

Yksi monipakkaus voi sisältää kaksi Phi Arrow valaisinta.
One multi package can include two Phi Arrow luminaire.

- 2.** Aseta valaisimet haluttuun järjestykseen,
Arrange the lights in the desired order.

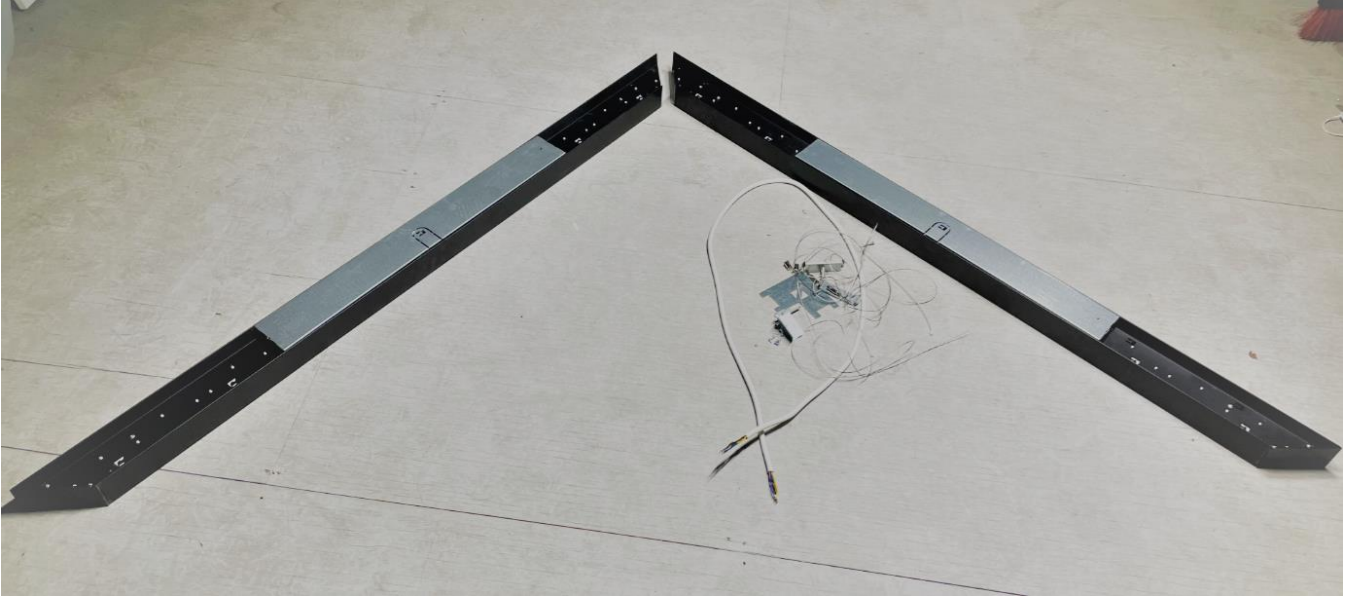

- 3.** Kohdista valaisinten kulmat paikoilleen. Tarkista että magneetti kulmapalat asettuu oikein.
Align the corners of the lights. Check that the magnetic corner pieces are positioned correctly.

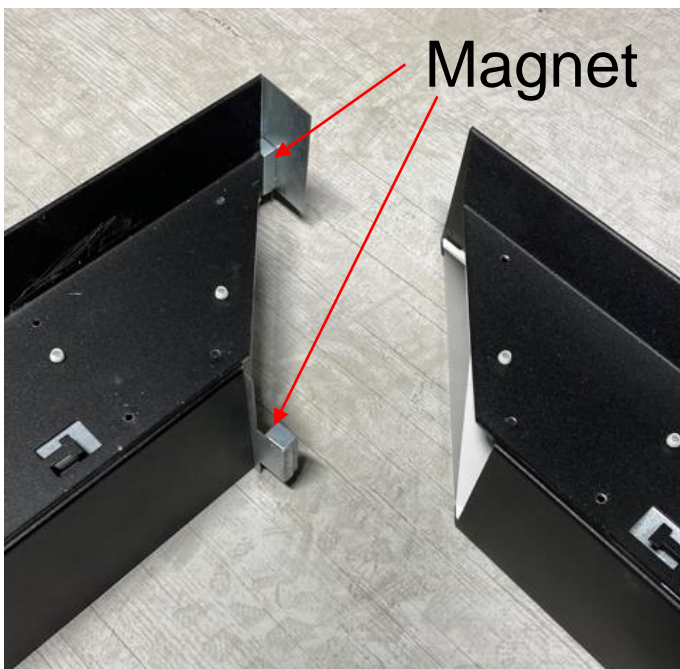

- 4.** Kiinnitä kulmapala kahdeksalla ruuvilla.
Fasten the corner piece with eight screws.

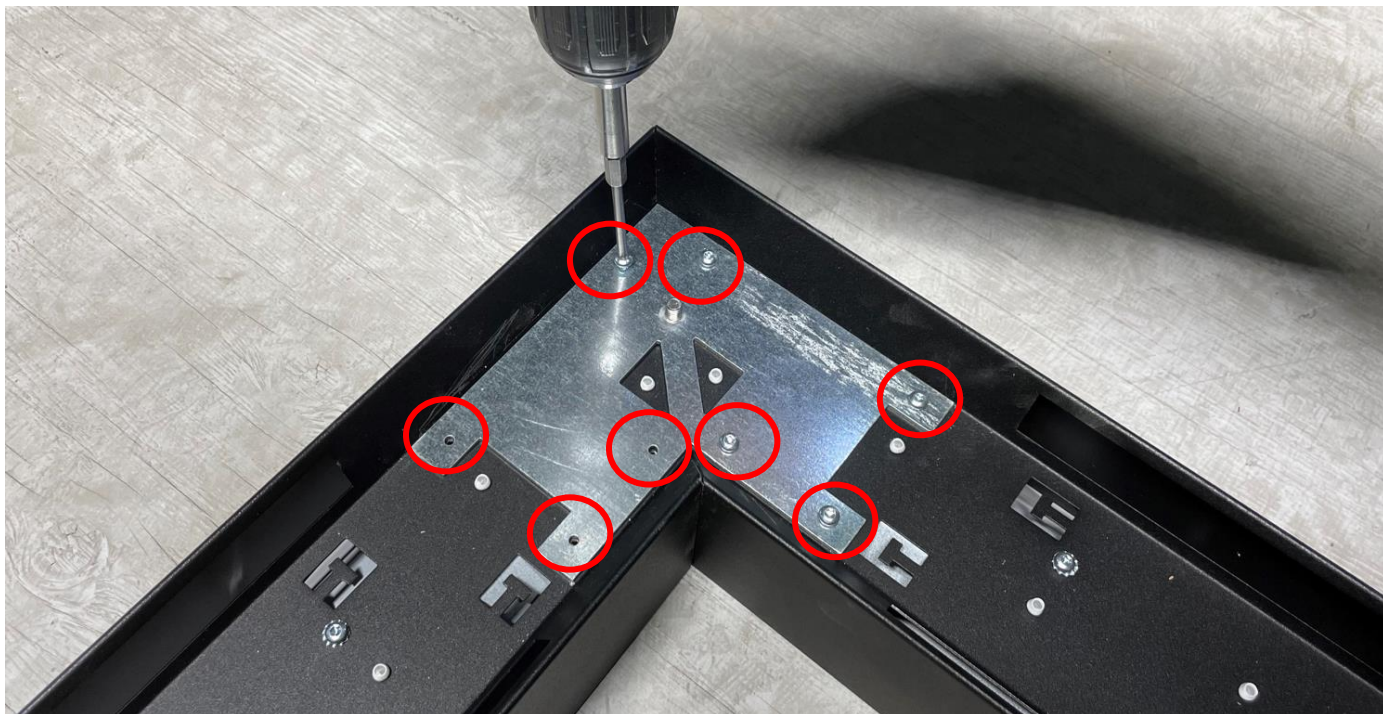

5.

Valaisimessa on säädettävät kiinnityspisteet sekä lisäksi kiinteät kiinnitys pisteet nurkissa. Kiinnityspisteiden paikat on kuvattu kohdassa 6.

The luminaire has adjustable attachment points as well as fixed attachment points in the corners. The locations of the attachment points are described in section 6.

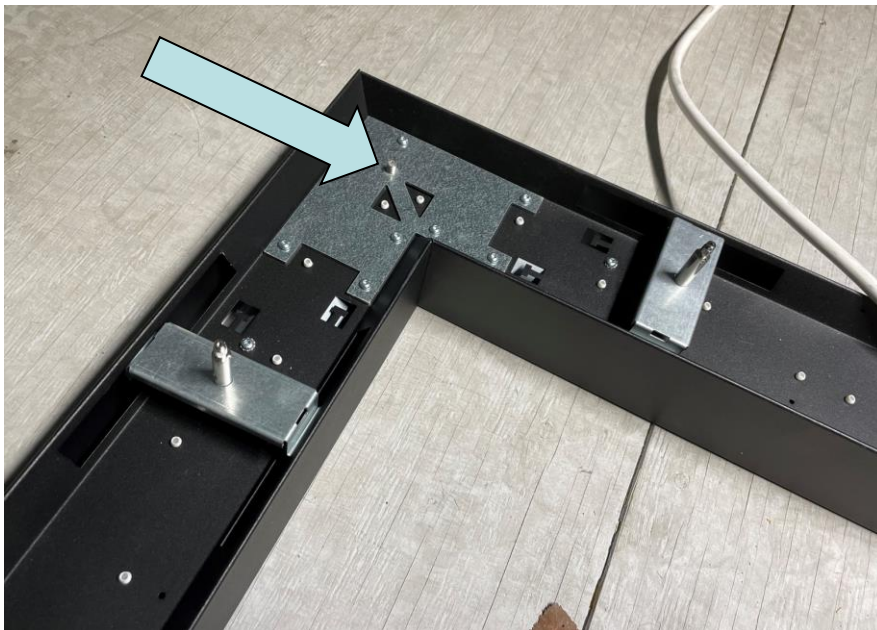
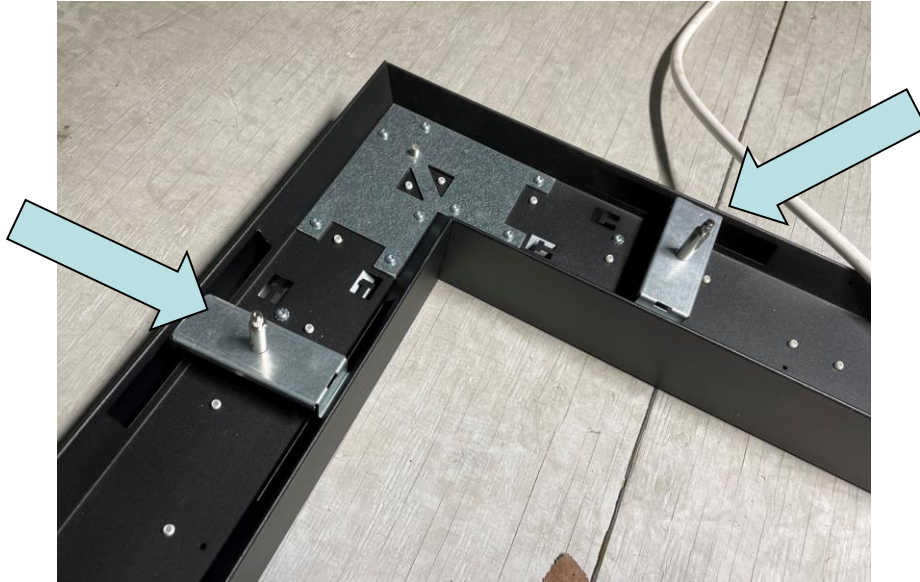

6. Kiinnityskohtien mitat 1245 ja 1805 valaisimeen.
Dimensions of mounting points for 1245 and 1805 luminaires.

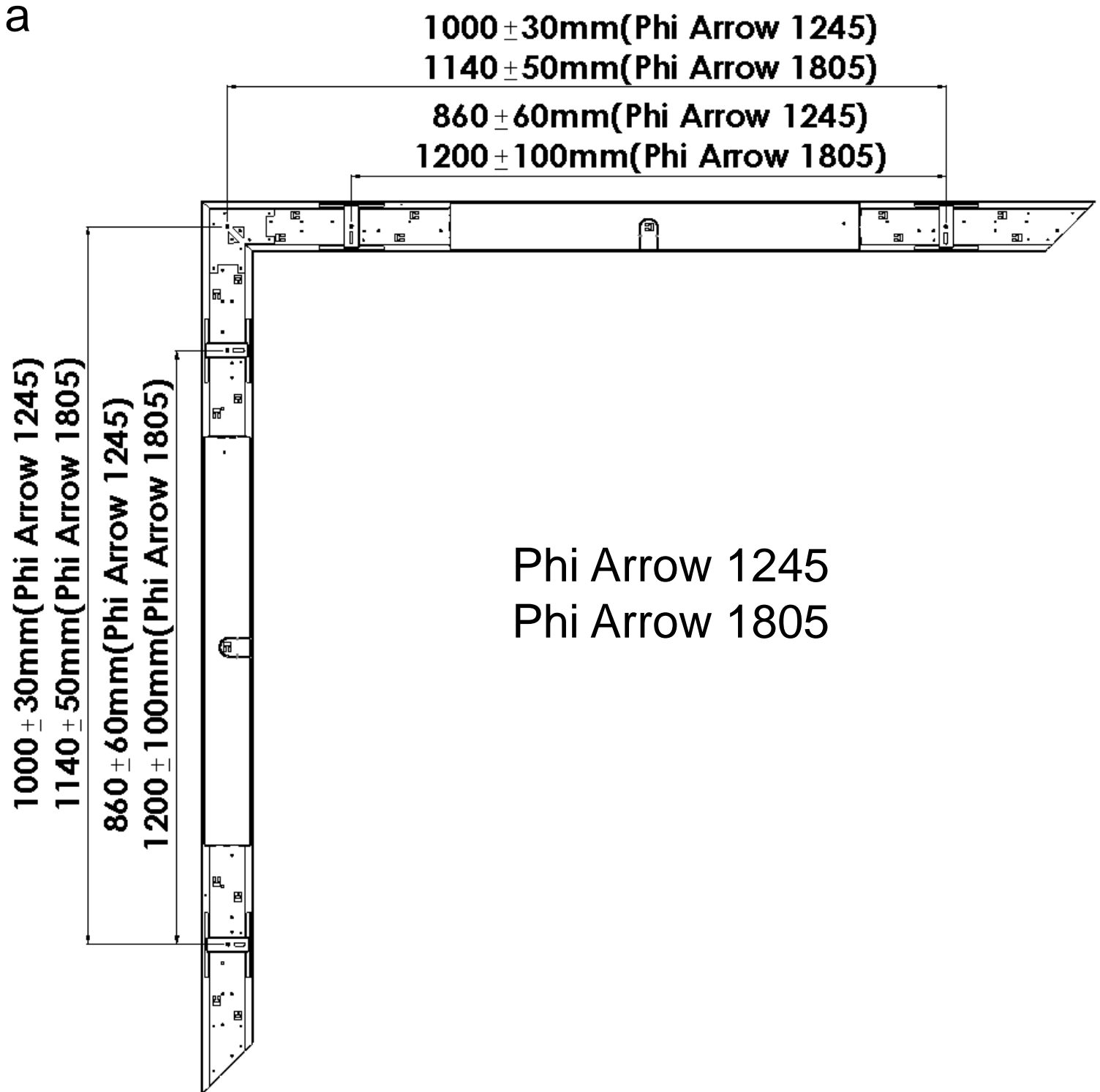

6. Kiinnityskohtien mitat 2365 valaisimeen.
Dimensions of mounting points for 2365 luminaires.

b

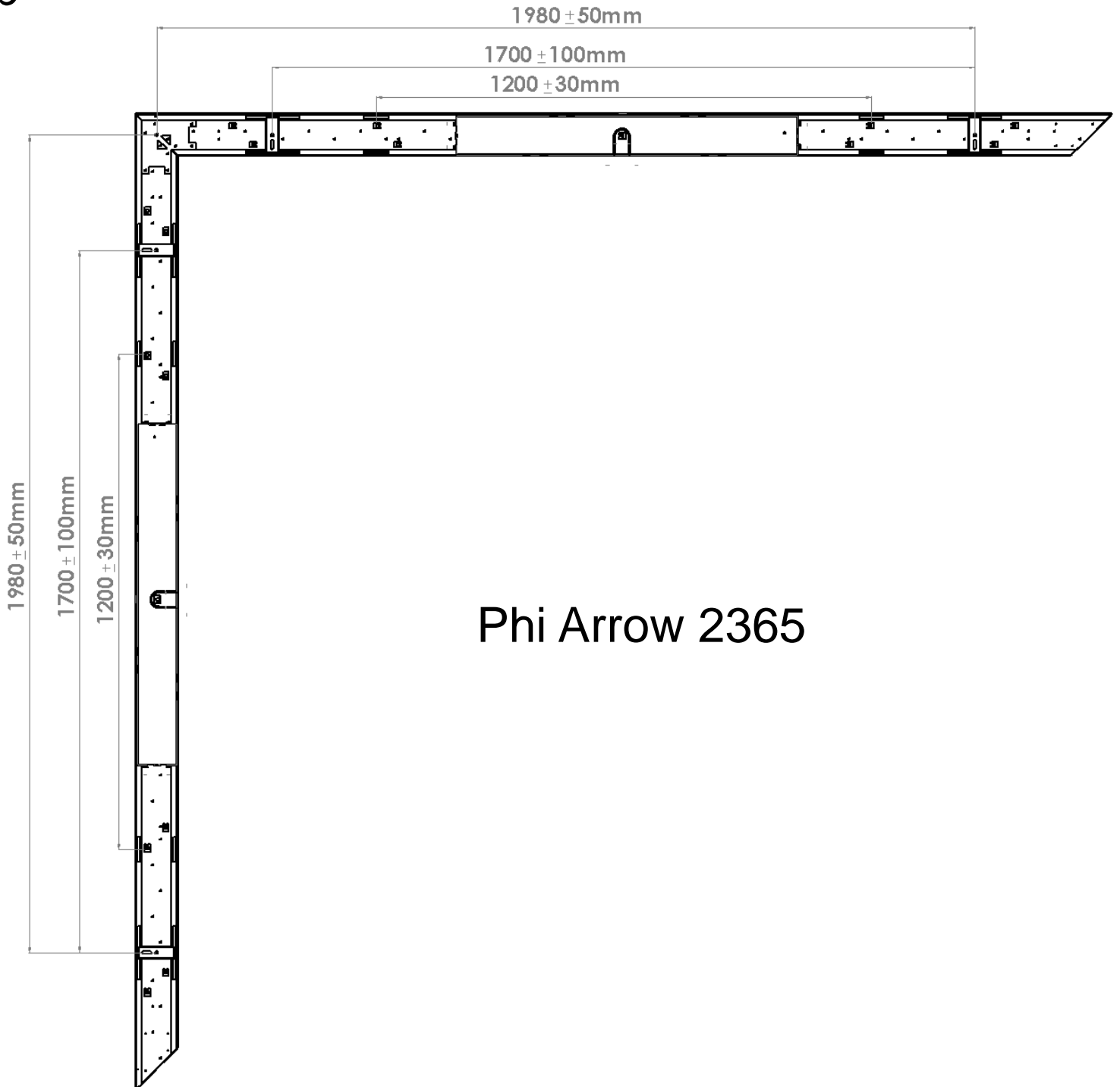

Phi Arrow 2365

6. Kiinnityskohtien mitat 2925 valaisimeen.
Dimensions of mounting points for 2925 luminaires.

C

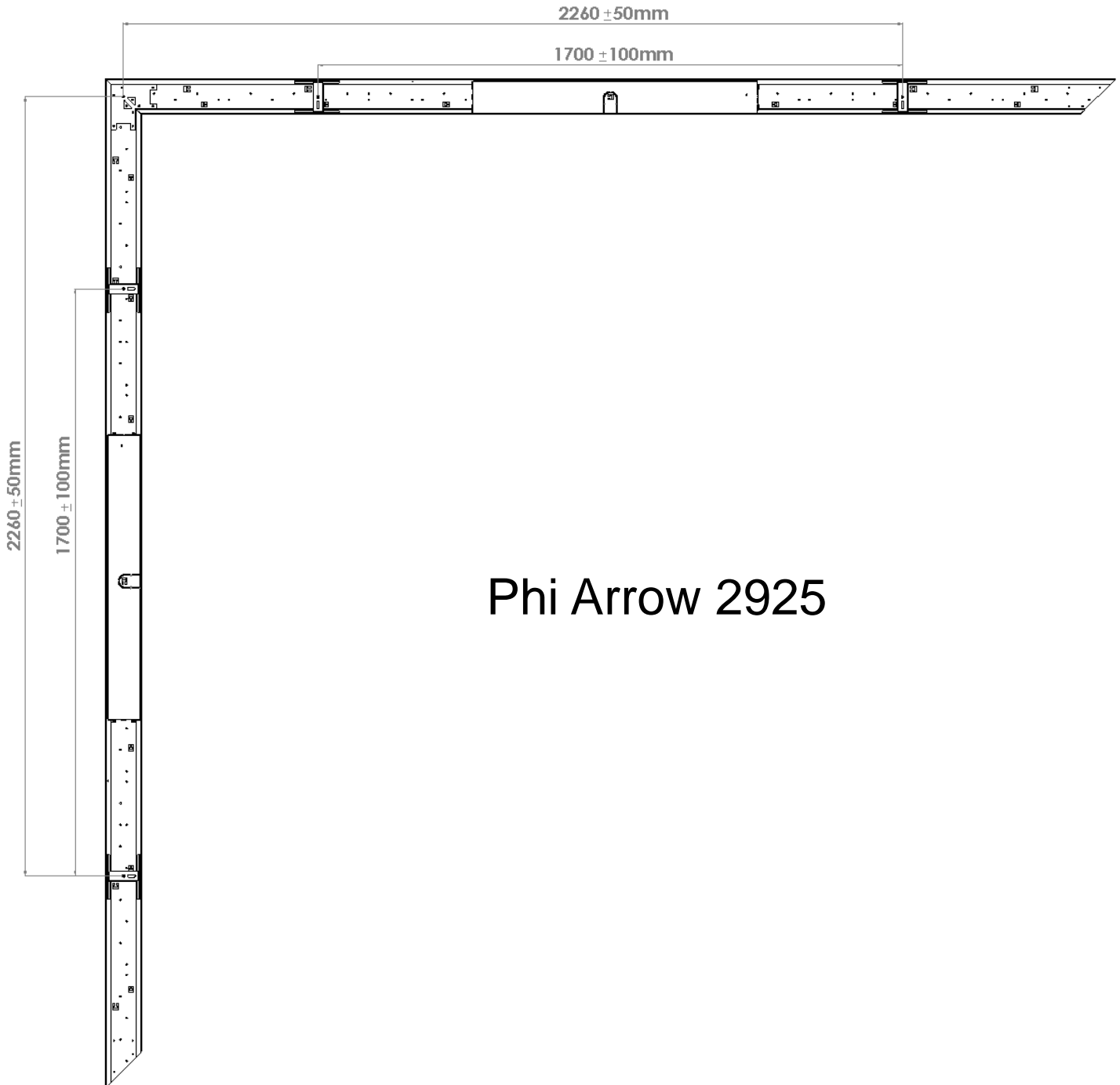

Phi Arrow 2925

7.

Vaijereiden kiinnitys asennettavaan pintaan Attaching the wires to the surface to be installed

a



Vaijerin yläpää on kiinnitettävä pintamateriaalin vaatimalla kiinnitystavalla.
The upper end of the cable must be fastened using the fastening method required by the surface material

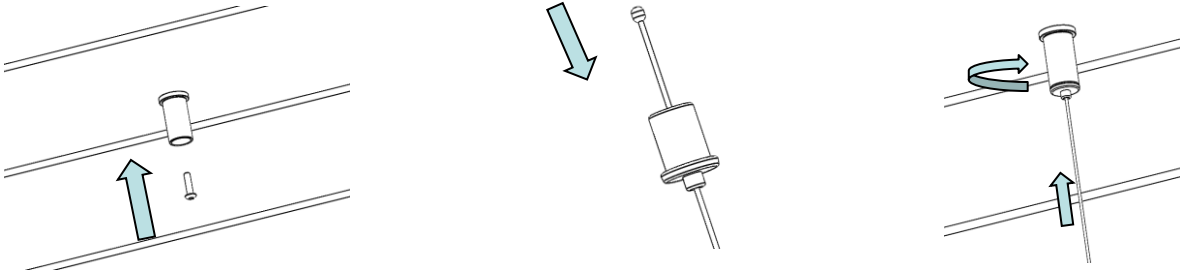

Mallin mitta Model measure	Teho Power	Paino Weight	Vaijereiden lukumäärä Number of wires	Yhden kiinnityspisteen kuorma Single anchor point load
GLPA0103012, PHI ARROW 1245	30W	8,8kg	(3)4	(26N/2,9kg)22N/2,2kg
GLPA0104412, PHI ARROW 1245	44W	8,8kg	(3)4	(26N/2,9kg)22N/2,2kg
GLPA0106212, PHI ARROW 1245	62W	8,8kg	(3)4	(26N/2,9kg)22N/2,2kg
GLPA0104418, PHI ARROW 1805	44W	12,1kg	(3)4	(40N4,1kg) 30N/3,0kg
GLPA0106618, PHI ARROW 1805	66W	12,1kg	(3)4	(40N4,1kg) 30N/3,0kg
GLPA0109018, PHI ARROW 1805	90W	12,1kg	(3)4	(40N4,1kg) 30N/3,0kg
GLPA0105823, PHI ARROW 2365	58W	15,2kg	4	37.5N/3,8kg
GLPA0108623, PHI ARROW 2365	86W	15,2kg	4	37.5N/3,8kg
GLPA0111623, PHI ARROW 2365	116W	15,2kg	4	37.5N/3,8kg
GLPA0106029, PHI ARROW 2925	60W	18,1kg	4	44.5N/4,5kg
GLPA0114429, PHI ARROW 2925	144W	18,1kg	4	44.5N/4,5kg



Taulukossa on oletettu, että valaisimen massasta aiheutunut kuorma on jakautunut tasaisesti kiinnityspisteiden suhteen.
In the table, it is assumed that the load caused by the mass of the lamp is evenly distributed in relation to the attachment points

- 7.** Tarkista että valaisin on suorassa, ja kiristä vaijerien lukinnat.
Check that the luminaire is straight and tighten the cable locks.

b

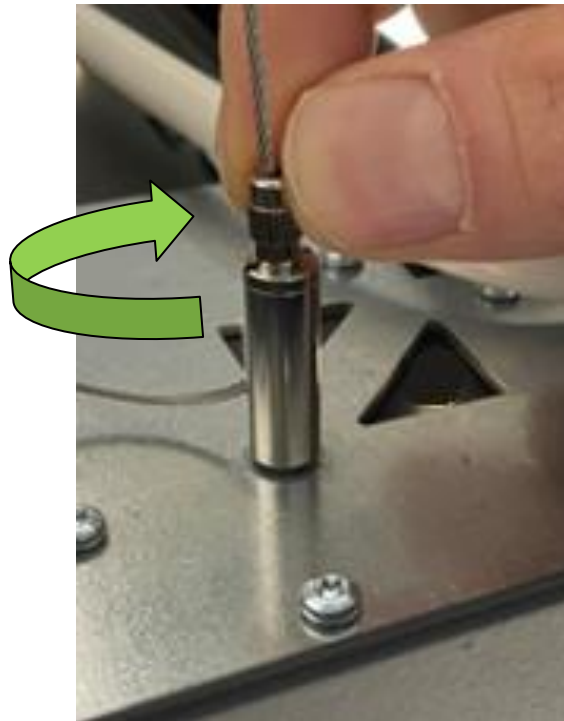

PHI ARROW

[FI] Asennusohje
[UK] Installation instruction
[SE] Installationsanvisning



Ohjauspiirin on oltava peruseristetty verkkojännitteestä | The control circuit must be basic insulated from the mains voltage
Styrkretsens måste vara grundisolerad från nätspänningen

8.

a

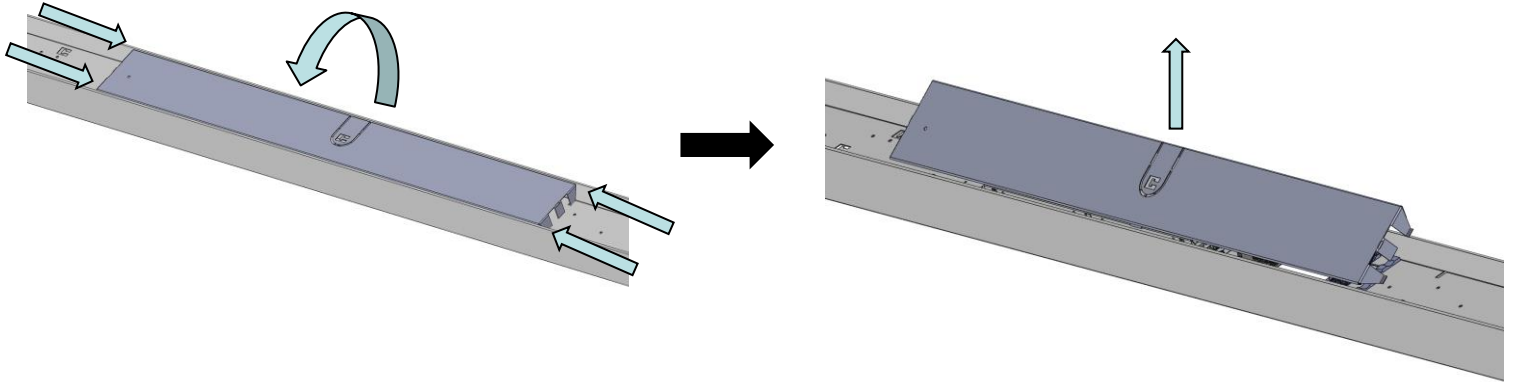

b

DALI

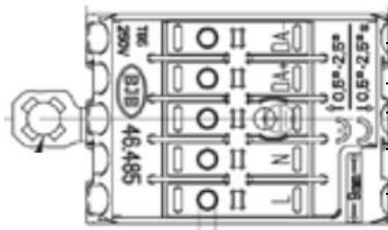

DA - = Harmaa, Grey, Grå

DA + = Musta, Black, Svart

⊕ = Kelta-Vihreä, Yellow-Green, Jordledning

N = Sininen, Blue, Blå

L = Ruskea, Brown, Brun

ON/OFF

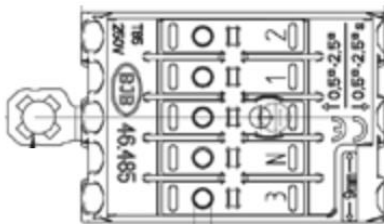

L = Ruskea, Brown, Brun

⊕ = Kelta-Vihreä, Yellow-Green, Jordledning

N = Sininen, Blue, Blå

8.

C

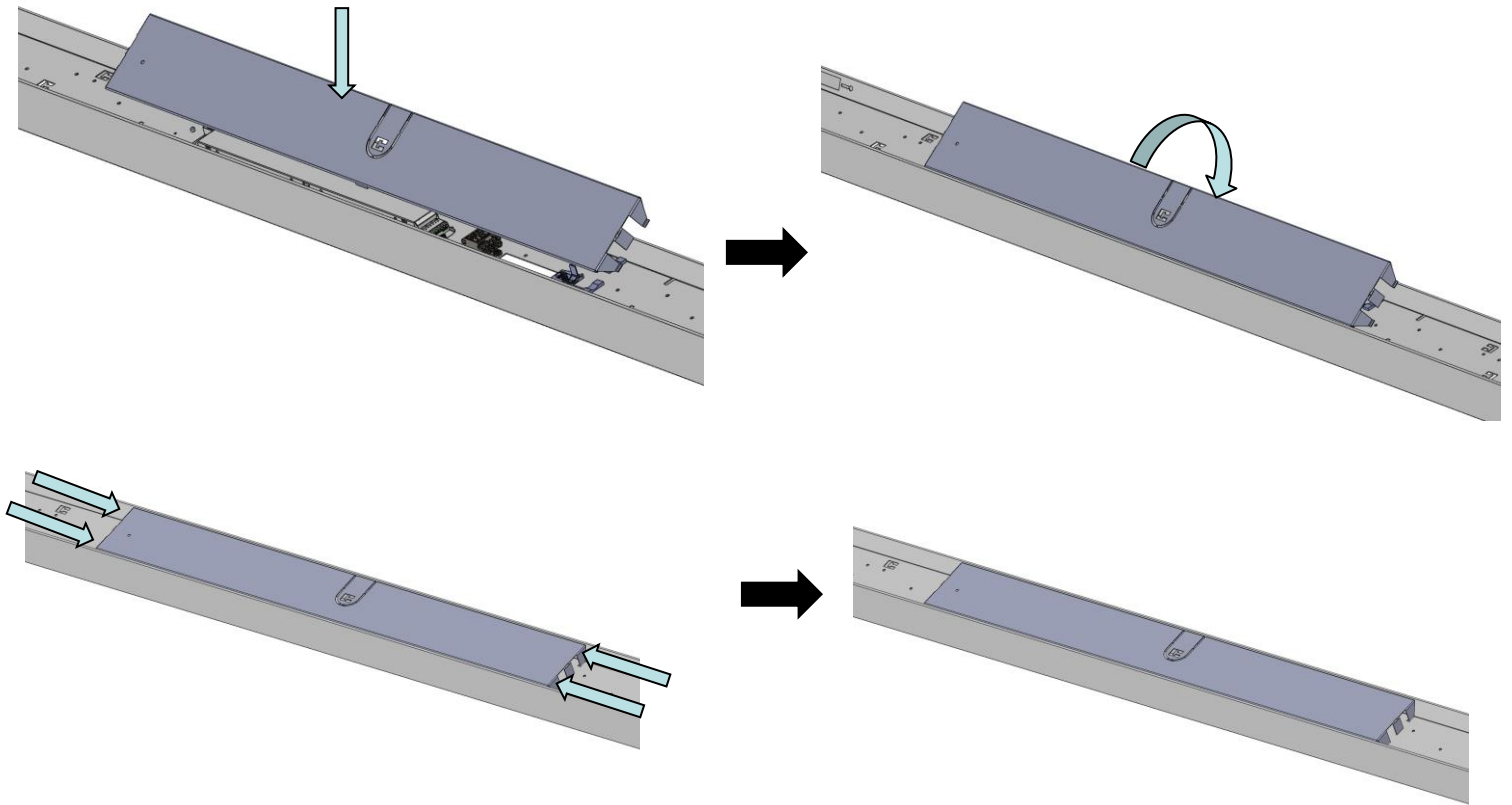

- d** Kiinnitä johtimet nippusiteillä, jotta ne eivät näy valaisimen sivusta.
Fasten the wires with cable ties so that they are not visible from the side of the lamp.



9. Casambi ohjaus, Casambi control

CASAMBI

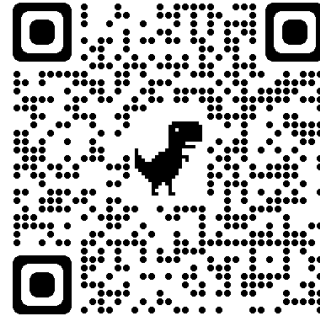

FI

Nämä ohjeet tulee säilyttää ja luovuttaa kiinteistön käyttäjälle.

UK

It is appropriate that this information is passed on to the user of the installation.

SE

Det är lämpligt att denna information överlämnas till användaren av anläggningen.

