

# PHI SQUARE

# GREENLED

[FI] Asennusohje  
[UK] Installation instruction  
[SE] Installationsanvisning

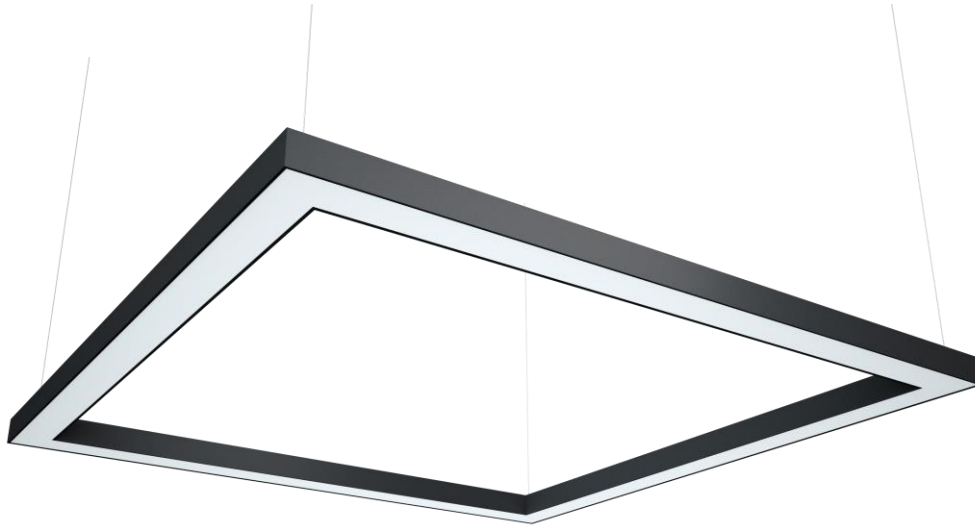
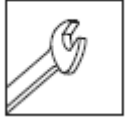

IP20

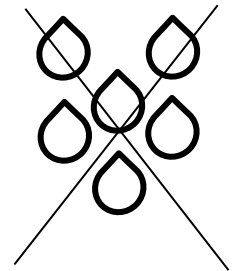

Mallin mitta Model measure	Teho Power	Paino Weight
GLPS0106012, PHI SQUARE 1245	60W	17,1kg
GLPS0108812, PHI SQUARE 1245	88W	17,1kg
GLPS0112412, PHI SQUARE 1245	124W	17,1kg
GLPS0108818, PHI SQUARE 1805	88W	23,9kg
GLPS0113218, PHI SQUARE 1805	132W	23,9kg
GLPS0118018, PHI SQUARE 1805	180W	23,9kg
GLPS0111623, PHI SQUARE 2365	116W	29,9kg
GLPS0117223, PHI SQUARE 2365	172W	29,9kg
GLPS0123223, PHI SQUARE 2365	232W	29,9kg
GLPS0112029, PHI SQUARE 2925	120W	35,8kg
GLPS0128829, PHI SQUARE 2925	288W	35,8kg

**Greenled Oy**  
Oritkarintie 4  
FI-90400 Oulu



DOC00346,2-ASENNUSOHJE,Phi Square

# GREENLED

# PHI SQUARE

[FI] Asennusohje  
[UK] Installation instruction  
[SE] Installationsanvisning

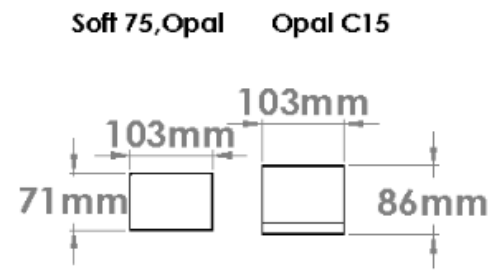
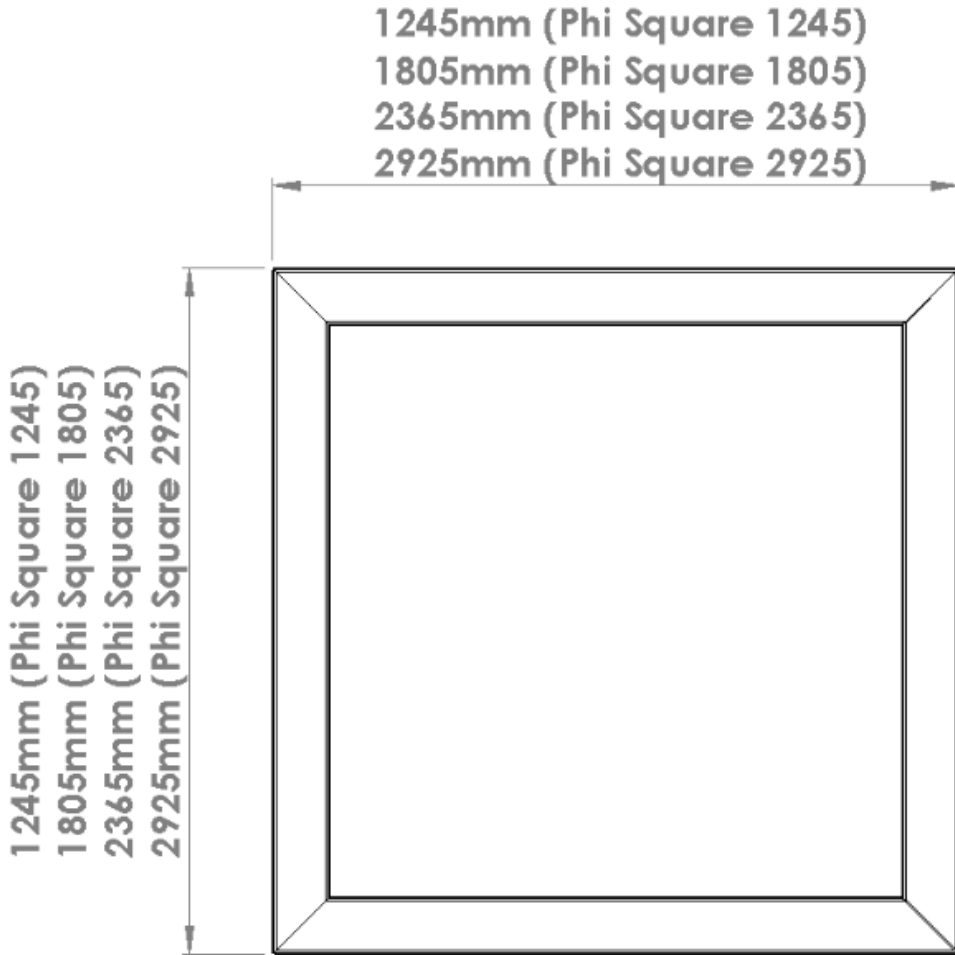



## Turvallisuusvaroitukset:

Ennen asennusta tai huoltotyötä kytke valaisin irti sähköverkosta välttääksesi sähköiskun vaaran!

- Asennus / huoltotyön saa tehdä vain valtuutettu henkilö
- Valaisimen asennuksen / huoltotyön saa suorittaa vain pätevä henkilö näiden ohjeiden mukaisesti.
- Valmistaja ei kanna vastuuta valaisimen väärästä käytöstä
- Älä katso suoraan päällä olevaan valaisimeen
- Valaisimen valonlähteen saa vaihtaa ainoastaan Greenled, Greenledin valtuuttama huoltaja tai vastaavan pätevyyden omaava henkilö

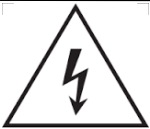

## Safety notes:

Before installation or change work disconnect the power to reduce electrical shock risk!

- Installation / maintenance can only be done by a skilled personnel
- Installation / maintenance of luminaire must be performed by qualified person following the instructions given in the instruction set
- The manufacturer bears no liability for damage caused by inappropriate use or application
- Do not stare at the operating light source
- The light source contained in this luminaire shall only be replaced by the Greenled or Greenled's service agent or a similar qualified person



## Säkerhetsvarningar:

Koppla alltid bort armaturen från elnätet i samband med installation ti den som använder armaturen.

- Installations- och underhållsarbeten får endast utföras av en behörig installatör
- Installations-/underhållsarbetet får endast utföras enligt dessa anvisningar av en person med tillräckliga kunskaper
- Tillverkaren ansvarar ej för felaktig användning av armaturen
- Titta aldrig rakt in i en påslagen armatur
- Ljuskällan inuti armaturen får endast bytas av antingen Greenled, en Greenled-auktoriserad servicetekniker eller en person med motsvarande kompetens

# PHI SQUARE

[FI] Asennusohje  
[UK] Installation instruction  
[SE] Installationsanvisning

## 1. Toimituksen sisältö. Delivery Contents.

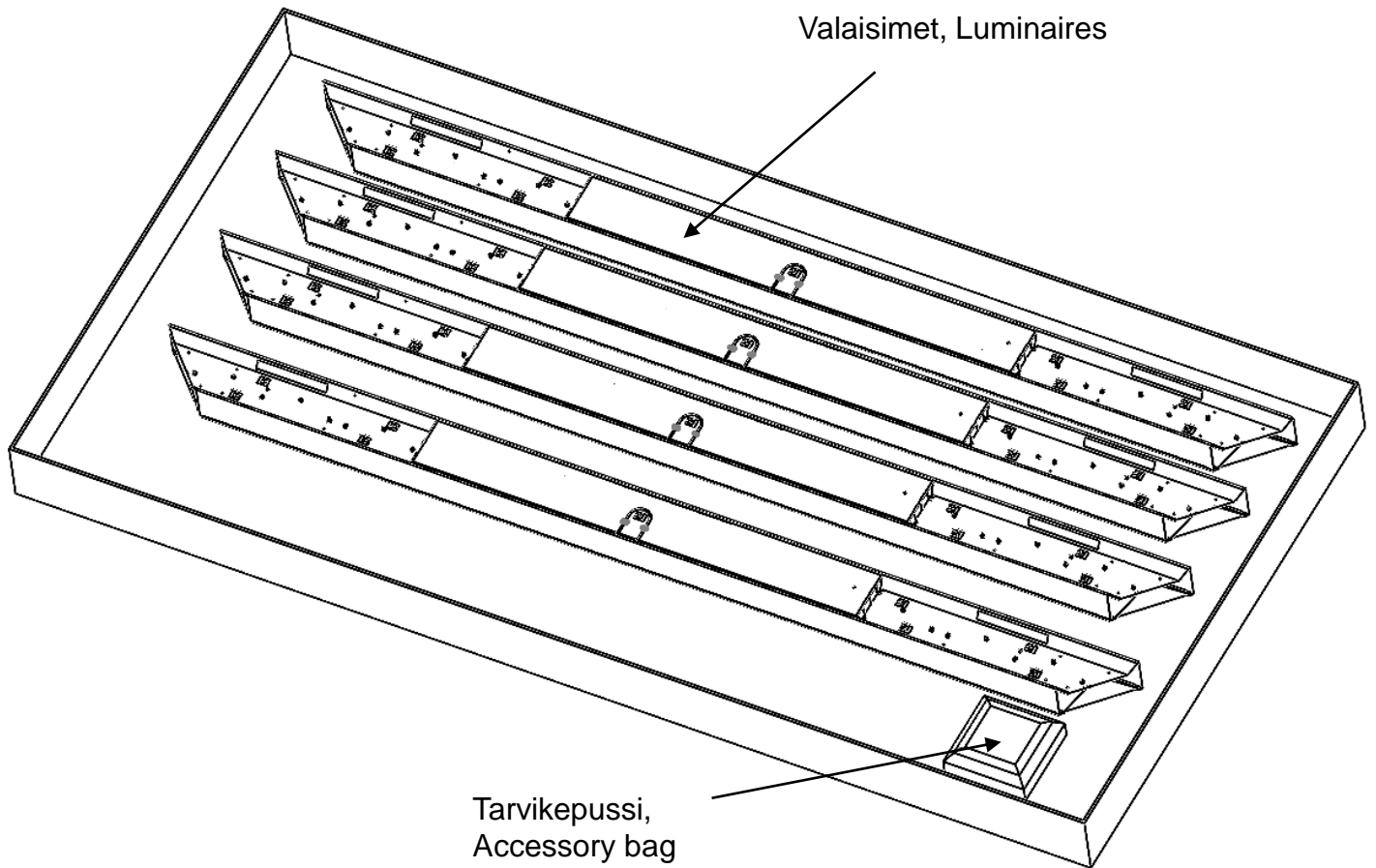

# PHI SQUARE

[FI] Asennusohje  
[UK] Installation instruction  
[SE] Installationsanvisning

- 2.** Aseta valaisimet haluttuun järjestykseen,  
Arrange the lights in the desired order.

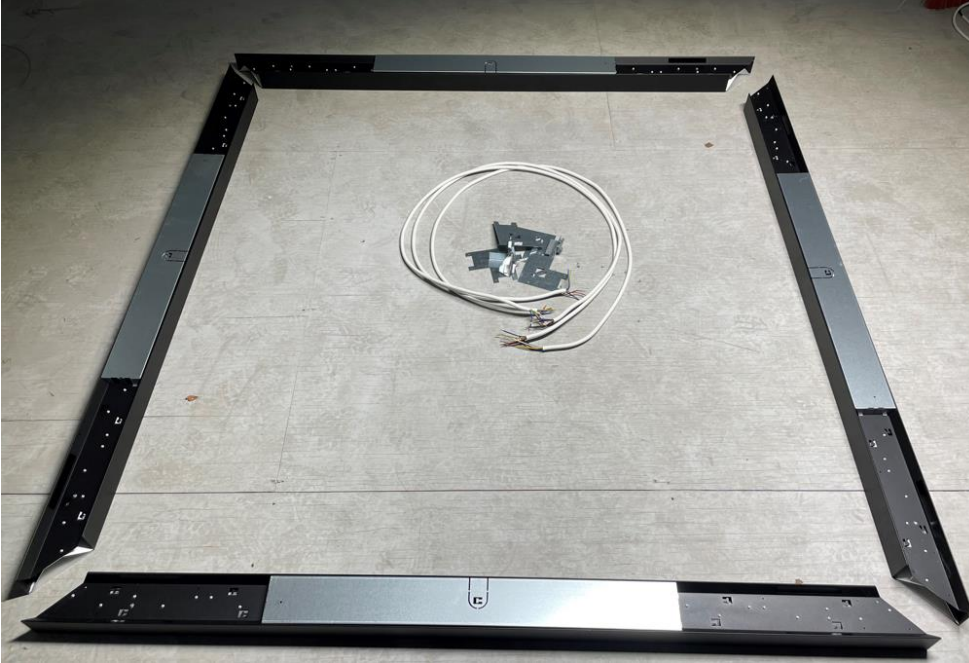

- 3.** Kohdista valaisinten kulmat paikoilleen. Tarkista että magneetti kulmapalat asettuu oikein.  
Align the corners of the lights. Check that the magnetic corner pieces are positioned correctly.

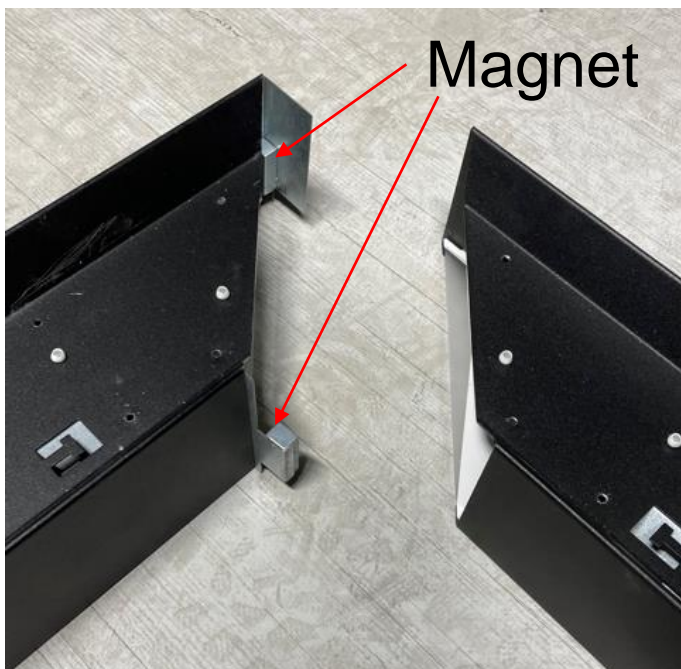

# PHI SQUARE

[FI] Asennusohje  
[UK] Installation instruction  
[SE] Installationsanvisning

- 4.** Kiinnitä kulmapalat kahdeksalla ruuvilla.  
Fasten the corner pieces with eight screws.

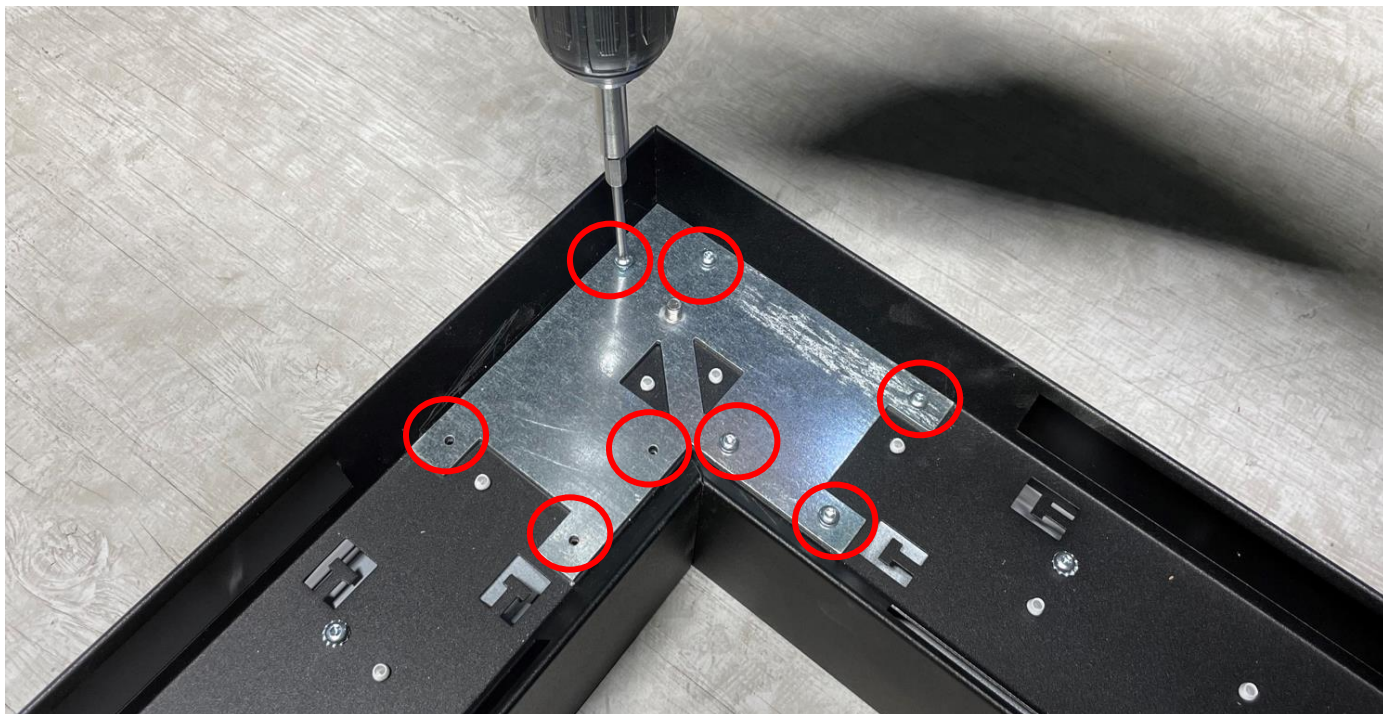

# PHI SQUARE

[FI] Asennusohje  
[UK] Installation instruction  
[SE] Installationsanvisning

**5.**

Valaisimessa on säädettävät kiinnityspisteet sekä lisäksi kiinteät kiinnityspisteet nurkissa. Kiinnityspisteiden paikat on kuvattu kohdassa 6.

The luminaire has adjustable attachment points as well as fixed attachment points in the corners. The locations of the attachment points are described in section 6.

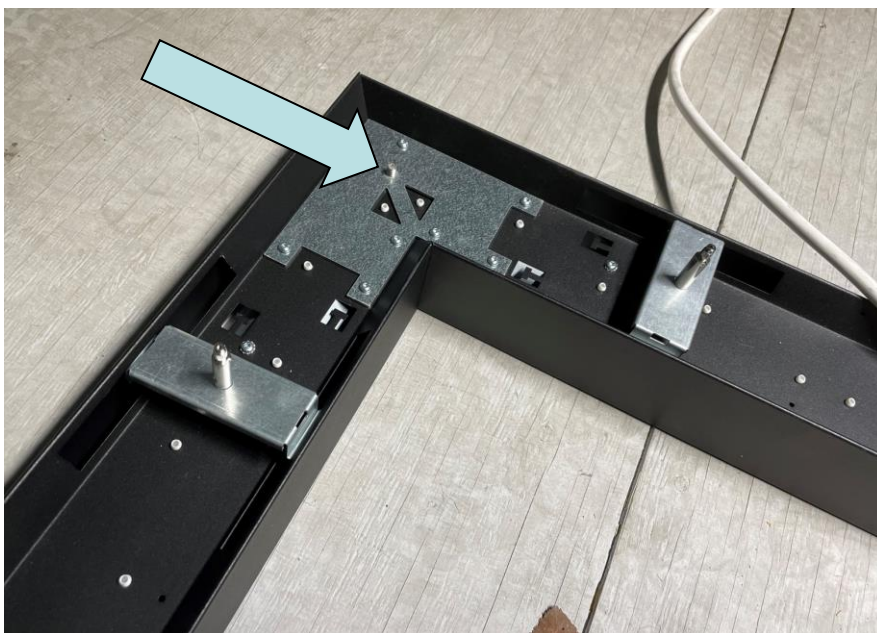

**6.** Kiinnityskohtien mitat 1245 ja 1805 valaisimeen.  
Dimensions of mounting points for 1245 and 1805 luminaires.

a

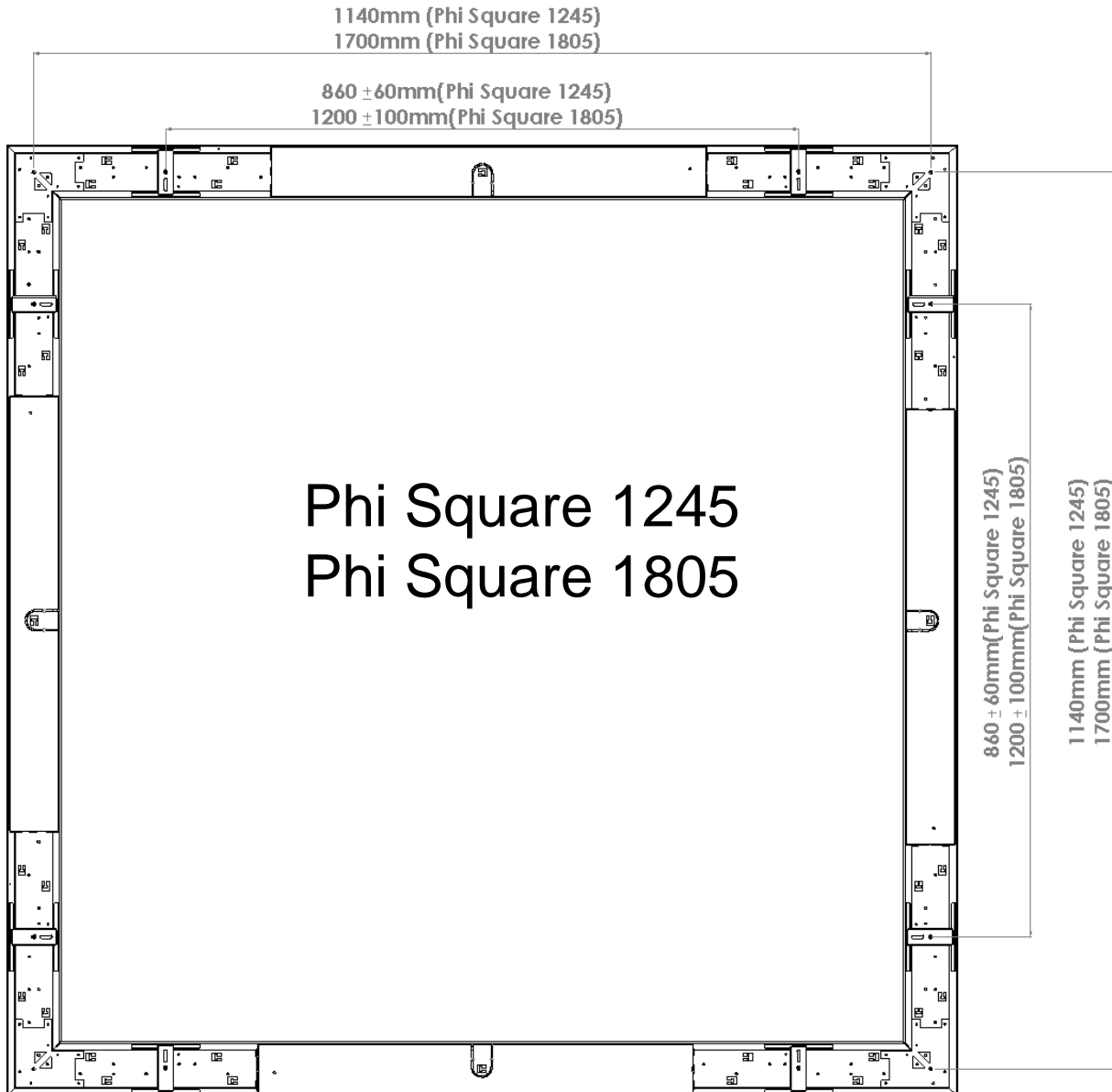



**6.** Kiinnityskohtien mitat 2365 valaisimeen.  
Dimensions of mounting points for 2365 luminaires.

b

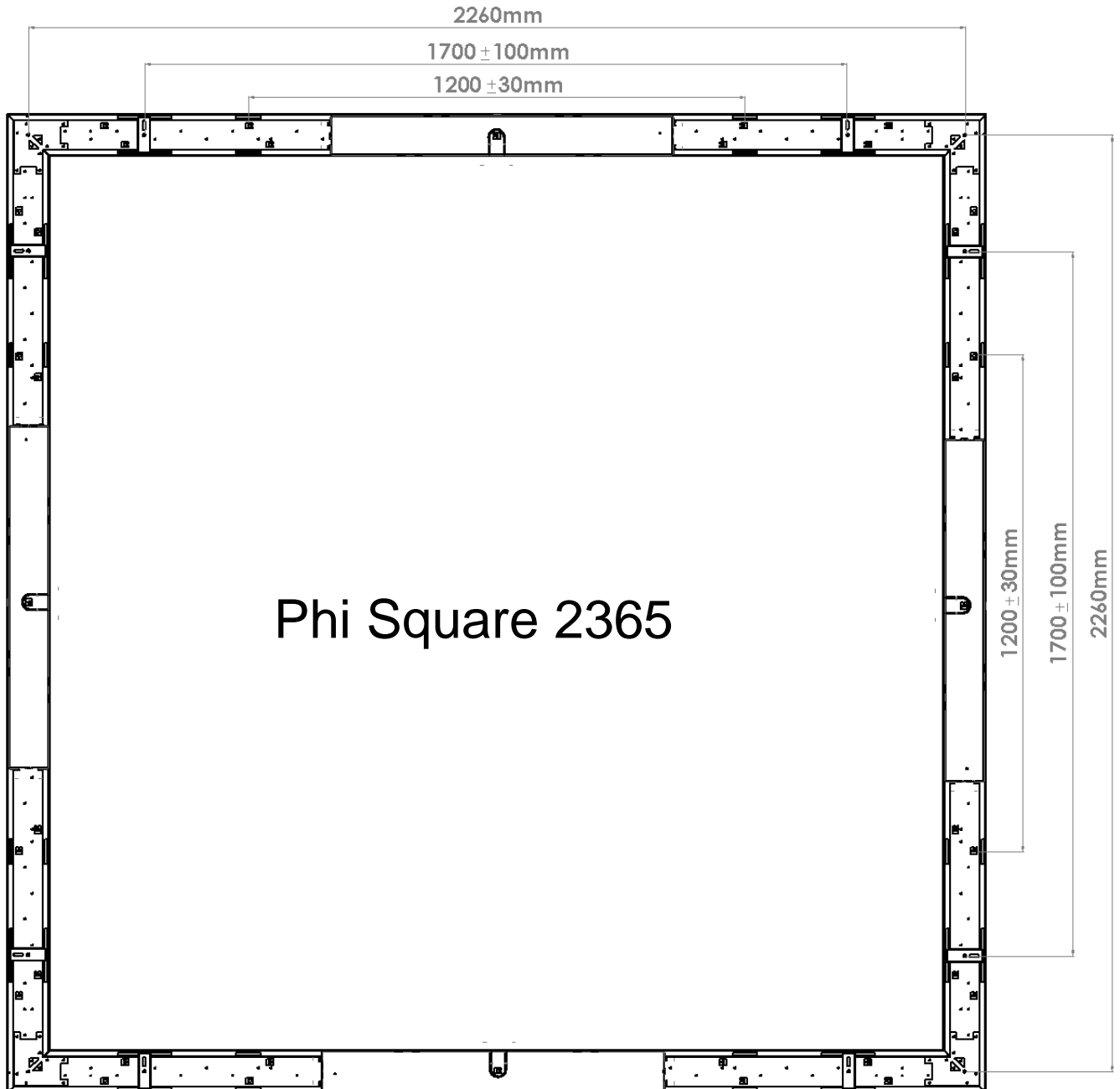

**6.** Kiinnityskohtien mitat 2925 valaisimeen.  
Dimensions of mounting points for 2925 luminaires.

C

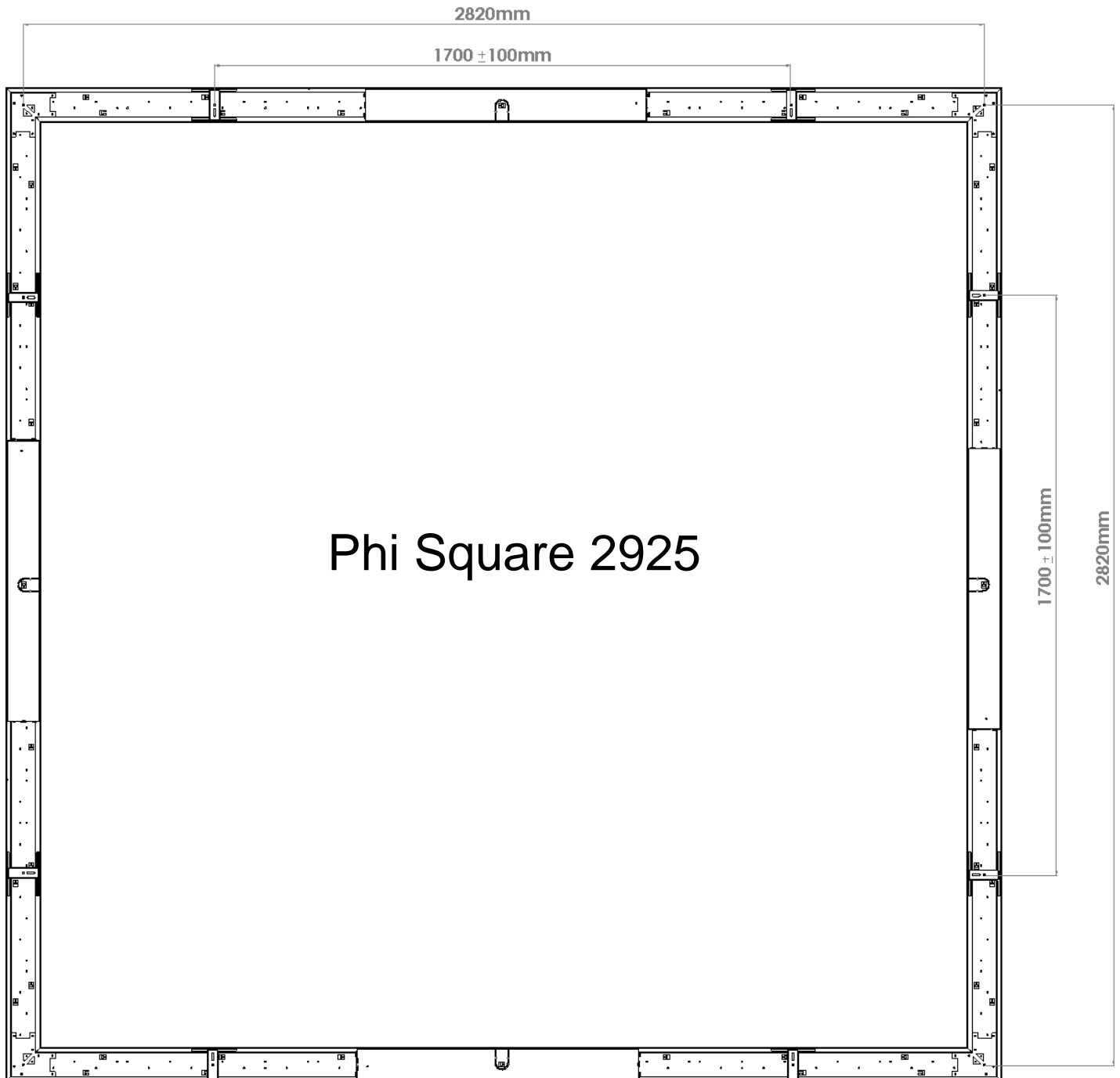

## 7. Vaijereiden kiinnitys asennettavaan pintaan Attaching the wires to the surface to be installed

a



Vaijerin yläpää on kiinnitettävä pintamateriaalin vaatimalla kiinnitystavalla.  
The upper end of the cable must be fastened using the fastening method required by the surface material

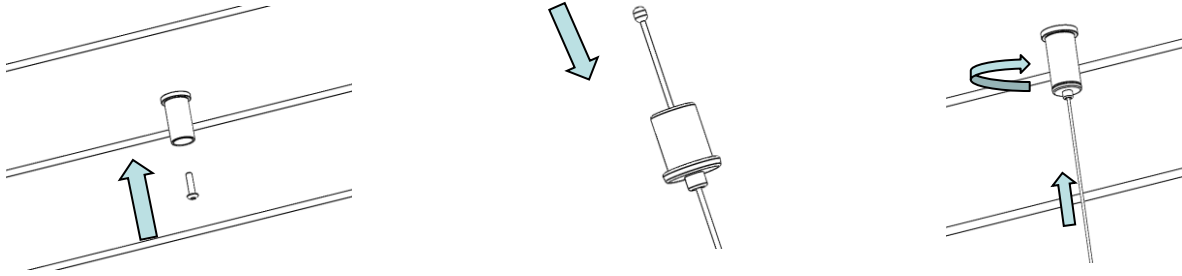

Malli Model	Teho Power	Paino Weight	Vaijereiden lukumäärä Number of wires	Yhden kiinnityspisteen staattinen kuorma Single anchor point load
GLPS0106012, PHI SQUARE 1245	60W	17,1kg	4	42N/4,3kg
GLPS0108812, PHI SQUARE 1245	88W	17,1kg	4	42N/4,3kg
GLPS0112412, PHI SQUARE 1245	124W	17,1kg	4	42N/4,3kg
GLPS0108818, PHI SQUARE 1805	88W	23,9kg	(4)/8	(60N/6,0kg)30N/3,0kg
GLPS0113218, PHI SQUARE 1805	132W	23,9kg	(4)/8	(60N/6,0kg)30N/3,0kg
GLPS0118018, PHI SQUARE 1805	180W	23,9kg	(4)/8	(60N/6,0kg)30N/3,0kg
GLPS0111623, PHI SQUARE 2365	116W	29,9kg	8	37N/3,75kg
GLPS0117223, PHI SQUARE 2365	172W	29,9kg	8	37N/3,75kg
GLPS0123223, PHI SQUARE 2365	232W	29,9kg	8	37N/3,75kg
GLPS0112029, PHI SQUARE 2925	120W	35,8kg	8	44N/4,5kg
GLPS0128829, PHI SQUARE 2925	288W	35,8kg	8	44N/4,5kg



Taulukossa on oletettu, että valaisimen massasta aiheutunut kuorma on jakautunut tasaisesti kiinnityspisteiden suhteen.  
In the table, it is assumed that the load caused by the mass of the lamp is evenly distributed in relation to the attachment points

# PHI SQUARE

[FI] Asennusohje  
[UK] Installation instruction  
[SE] Installationsanvisning

- 7.** Tarkista että valaisin on suorassa, ja kiristä vaijerien lukinnat.  
Check that the luminaire is straight and tighten the cable locks.

b

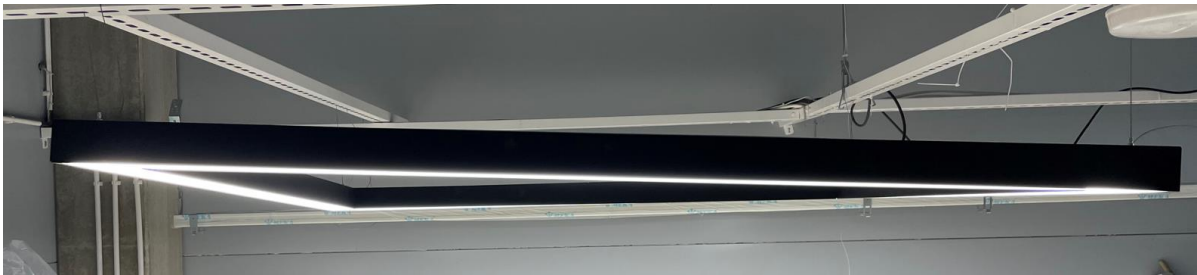

# PHI SQUARE

[FI] Asennusohje  
[UK] Installation instruction  
[SE] Installationsanvisning



Ohjauspiirin on oltava peruseristetty verkkojännitteestä | The control circuit must be basic insulated from the mains voltage  
Styrkretsens måste vara grundisolerad från nätspänningen

8.

a

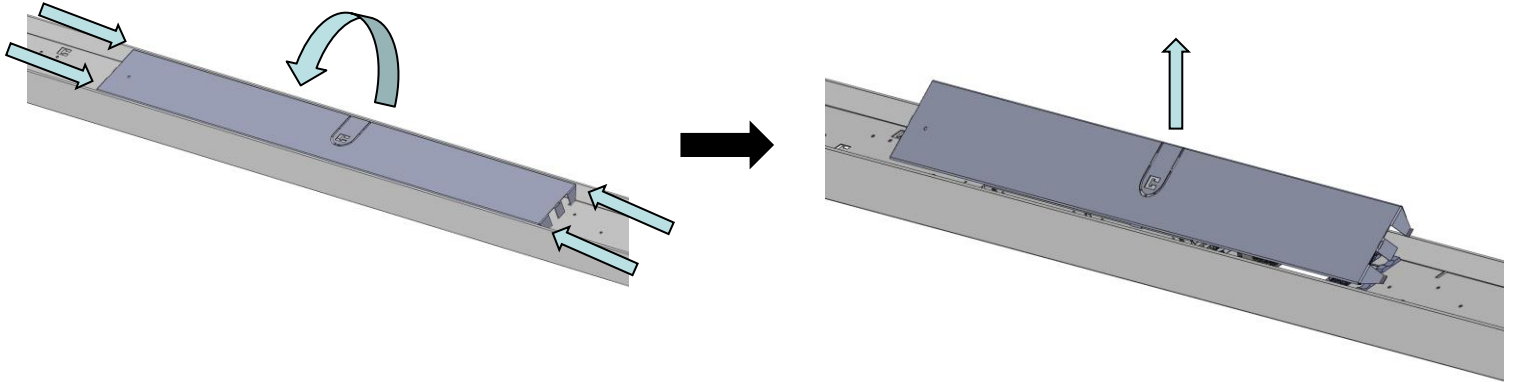

b

DALI

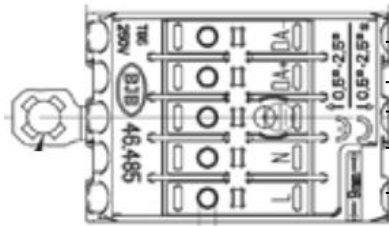

DA - = Harmaa, Grey, Grå

DA + = Musta, Black, Svart

⊕ = Kelta-Vihreä, Yellow-Green, Jordledning

N = Sininen, Blue, Blå

L = Ruskea, Brown, Brun

ON/OFF

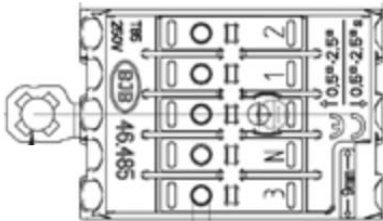

L = Ruskea, Brown, Brun

⊕ = Kelta-Vihreä, Yellow-Green, Jordledning

N = Sininen, Blue, Blå

# PHI SQUARE

[FI] Asennusohje  
[UK] Installation instruction  
[SE] Installationsanvisning

8.

C

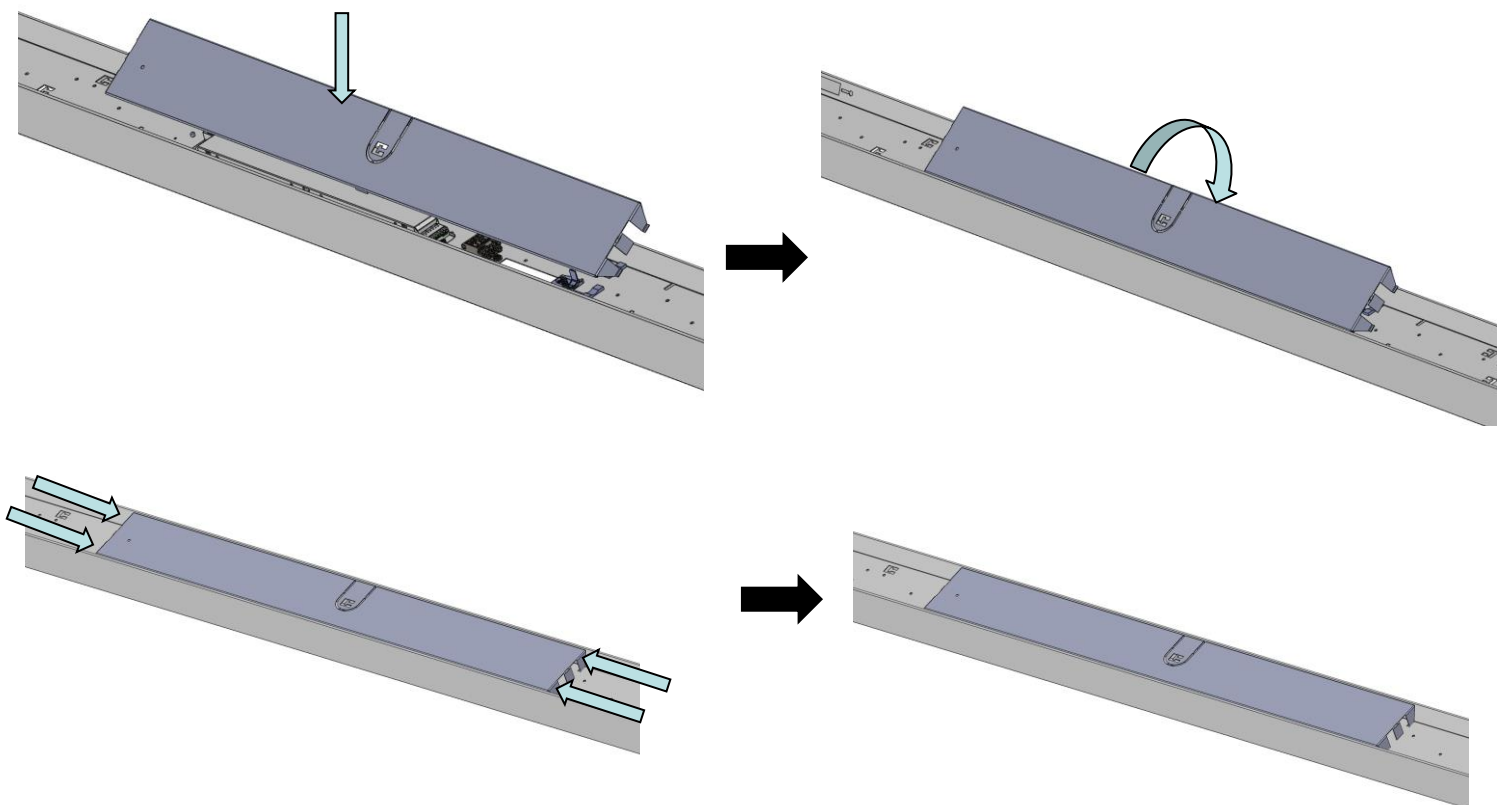

d

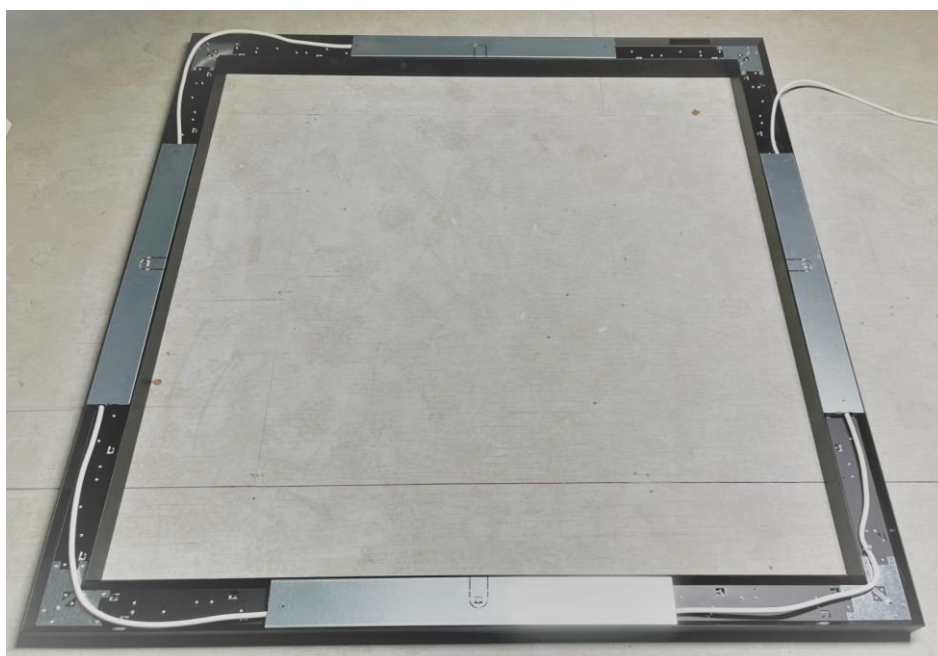

- 8.** Kiinnitä johtimet nippusiteillä, jotta ne eivät näy valaisimen sivusta.  
Fasten the wires with cable ties so that they are not visible from the side of the lamp.

e

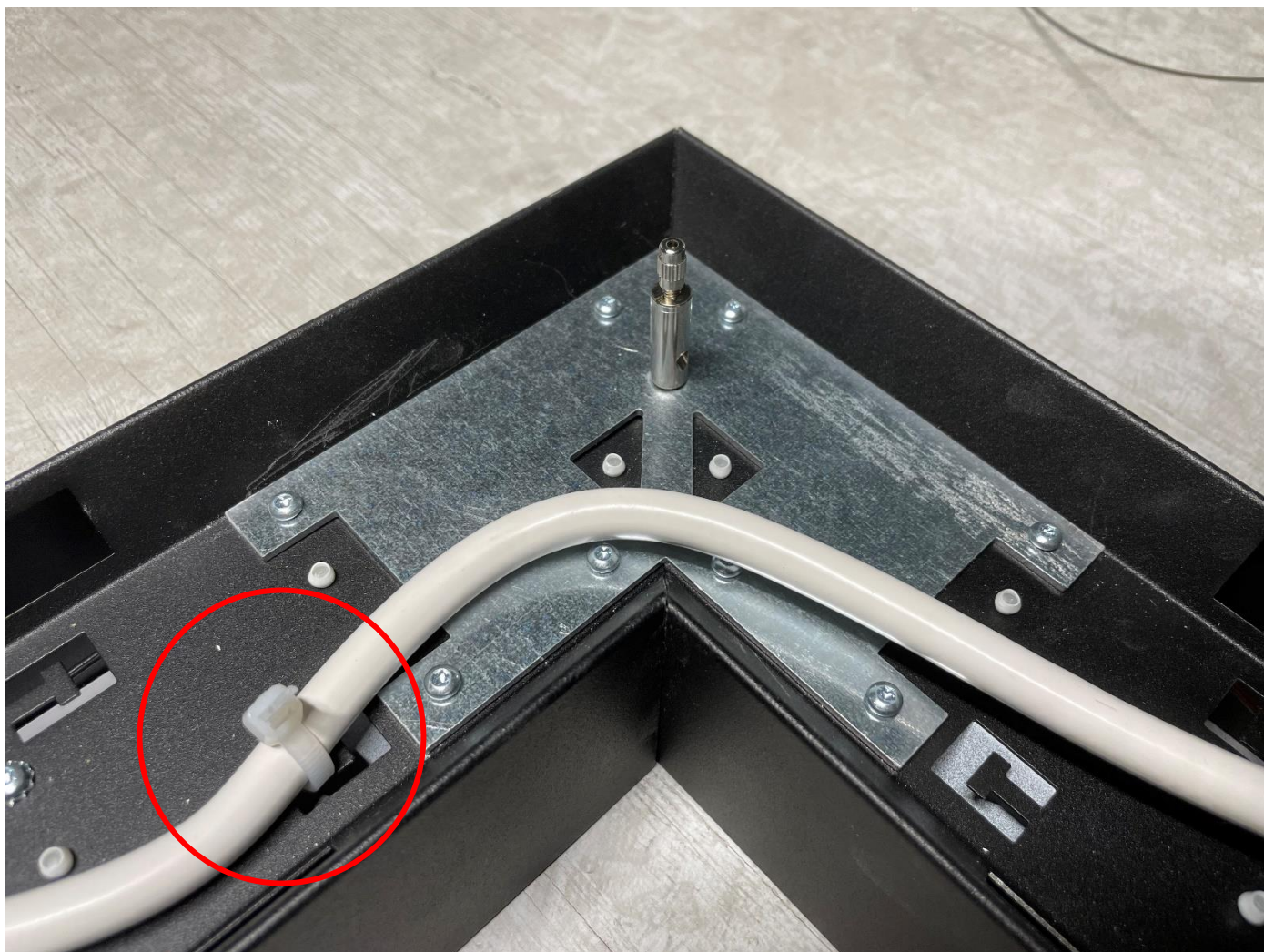

## 9. Casambi ohjaus, Casambi control

CASAMBI

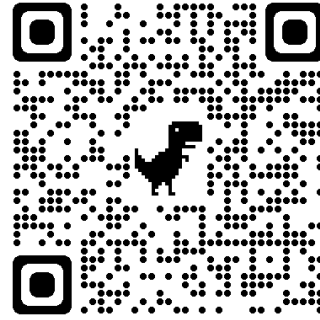

FI

Nämä ohjeet tulee säilyttää ja luovuttaa kiinteistön käyttäjälle.

UK

It is appropriate that this information is passed on to the user of the installation.

SE

Det är lämpligt att denna information överlämnas till användaren av anläggningen.

